

Article number: 01010341
 Description: Retaining ring A 18 DIN 471
 Stainless 411
 Note: Fitted with ZGA pilers

Measures

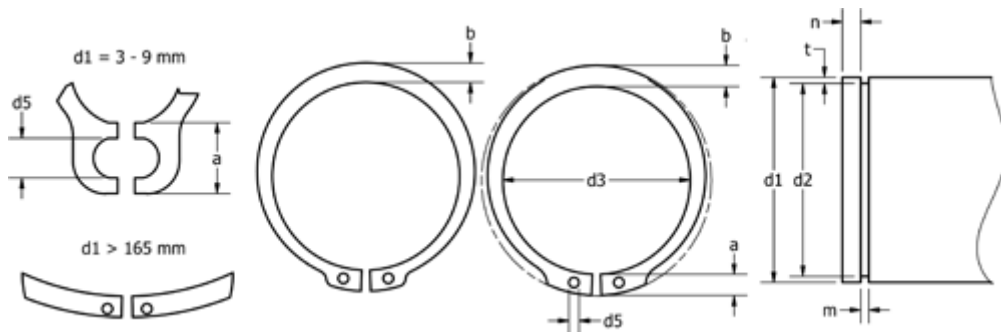

a max	= 3.9	FN kN	= 4.5	s	= 1.20
AN mm ²	= 27.5	FRg kN	= 3.75	t	= 0.50
b	= 2.4	FR kN	= 17.00	tol	= -0.11
d1	= 18	g	= 1.5	tol	= -0.06
d2	= 17.0	K kN-mm	= 37.10	tol	= +0,10-0,36
d3	= 16.5	m min	= 1.30	Tong	= ZGA-2
d5 min	= 2.0	n abl x 1000	= 39.0	Weight kg/1000	= 1.110
Description	= A18	Nominal drive	= 1.5		